



EPISODE 54

Solis S6 Advanced Power Hybrid Inverter
bring more uninterrupted power to your family

Bankable. Reliable. Local.

Solis S6 Advanced Power Hybrid Inverter bring more uninterrupted power to your family

>> Background

Power shortage has become a long-term issue in South Africa. There were 205 consecutive days of power outages here in 2022, and this has lasted every day since the beginning of 2023. The increasingly severe power shortage has seriously affected people's daily lives as well as the development of the socio-economy. As South Africa experiences power outages for up to 10 hours a day, President Cyril Ramaphosa declared a national "state of disaster" on Thursday to address the power crisis. Under the power supply constraints, the demand for reliable and stable power supply from residents drives South African household photovoltaic + energy storage to become one of the best choices for local energy utilization. According to the Council for Energy Storage (CES) forecast, South Africa's cumulative installed capacity for ground energy storage is expected to reach 14.8 GWh by 2030.

In this context, Solis launched the Solis S6 Advanced Power Hybrid Inverter on April 25, 2023, with the goal of injecting new energy into South African residential and commercial power and releasing more people from the effects of power outages. The introduction of the new product brought about a strong response in the local market. This Solis seminar will provide a comprehensive overview of the new product's features.

I. About the Solis S6 Advanced Power Hybrid Inverter

The Solis S6 Advanced Power Hybrid Inverter is specifically designed for residential and commercial photovoltaic energy storage systems, with a maximum power of 48kW and support for multiple parallel single-phase or three-phase systems. It has a UPS-level switching time of 4ms with a 10s surge power overload. It supports connection with generators of various input methods and has a variety of intelligent protection functions to ensure the safety and reliability of household power supply. The recent introduction of this new product brought about a strong response in the local market.

>> Solis Hybrid Inverter

Solis S6 Advanced Power Hybrid Inverter

- Generator connectivity with multiple input methods and automatic generator On/Off control
- Automatic UPS switching, switching time within 4ms
- Supports 1ph and 3ph flexible connection with max 48kW in parallel
- Up to 190A max charge/discharge current
- 6 customizable charge/discharge time settings
- Supports self-use/grid priority/backup/peak shaving and other working modes to meet different application scenarios
- Compatible with lead-acid and lithium batteries, with multiple battery protection features
- 10 second 200% surge power backup overload capability



— S6-EH1P8K-L-PRO

II. Efficient and Reliable Energy Security - Breaking Free from Power Outages

Based on the residential green power solution of the Solis S6 Advanced Power Hybrid Inverter, the primary goal is to provide customers with a reliable and independent energy supply to reduce electricity expenses and ensure the availability of electricity use. During the day when photovoltaic power generation exceeds load demand, it first supplies power to local loads while charging the battery; if there is excess power, it can be sold to the main power grid; at night, the battery pack discharges to supply load demand; when the power grid is interrupted, the system can independently supply power to household appliances for an extended period.

1. Compatibility with various generators

In areas with frequent power interruptions, using a generator as a backup power source is a common and necessary method. The Solis S6 Advanced Power Hybrid Inverter can work in conjunction with a diesel generator and provide various diesel generator connection options. In addition to a traditional grid connection and Automatic Transfer Switch (ATS) conversion connection, the product also has an independent generator access port. Users can supply power to the load by connecting the generator to the inverter without changing the existing wiring. It can also send control signals to automatically start or stop the diesel generator as needed, avoiding diesel waste and long-term diesel engine noise.

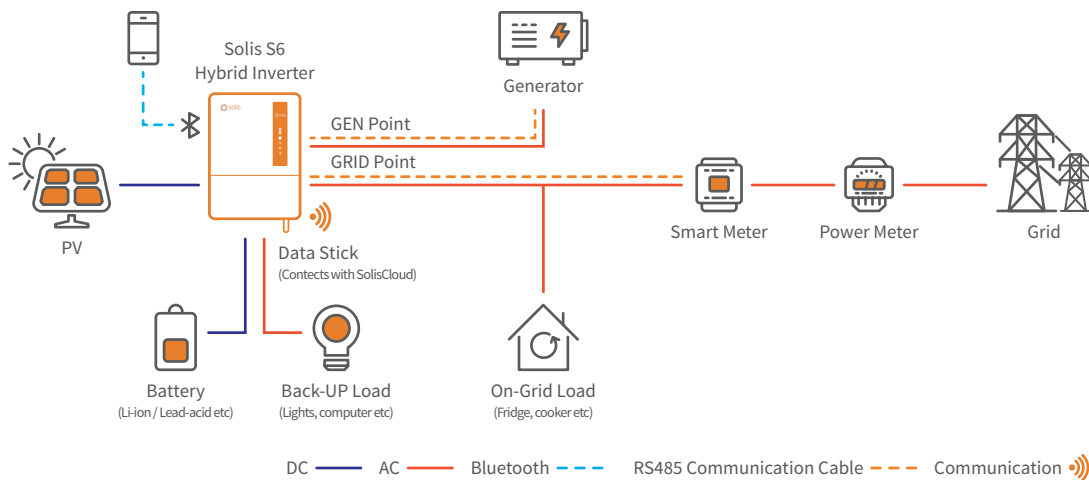

— GEN port directly connects the generator

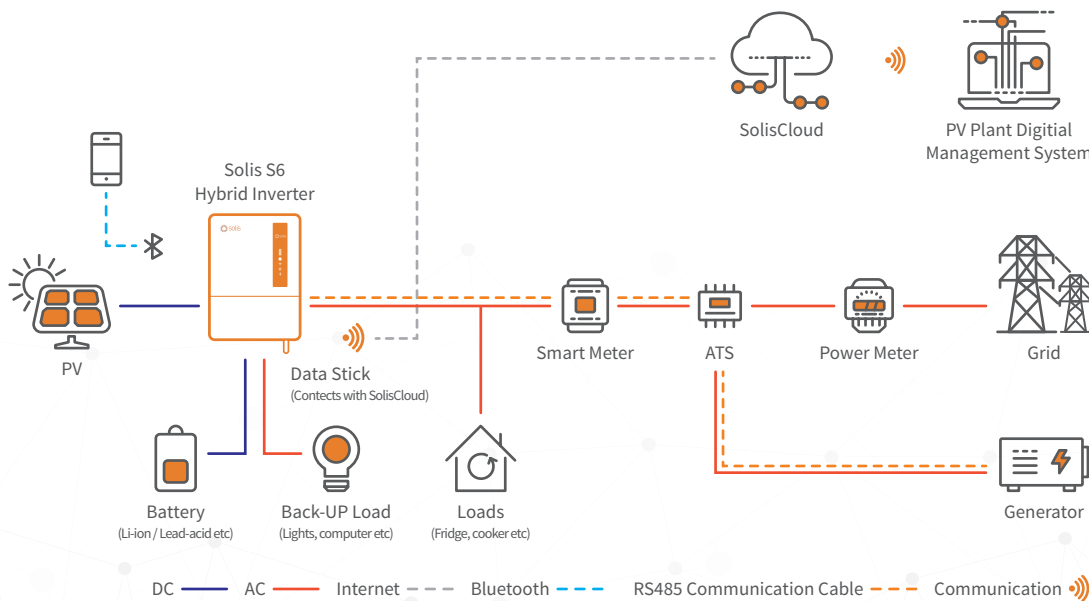

— Through ATS or grid port connects the generator

2. Automatic switching

During normal operation, if the power is suddenly interrupted, the backup power equipment will provide a smooth and uninterrupted power supply to the load, ensuring that the load work is not affected. The Solis S6 Advanced Power Hybrid Inverter can provide UPS-level switching with a switching time $< 4\text{ms}$, achieving truly seamless switching, allowing users to completely break free from the troubles of power interruptions.

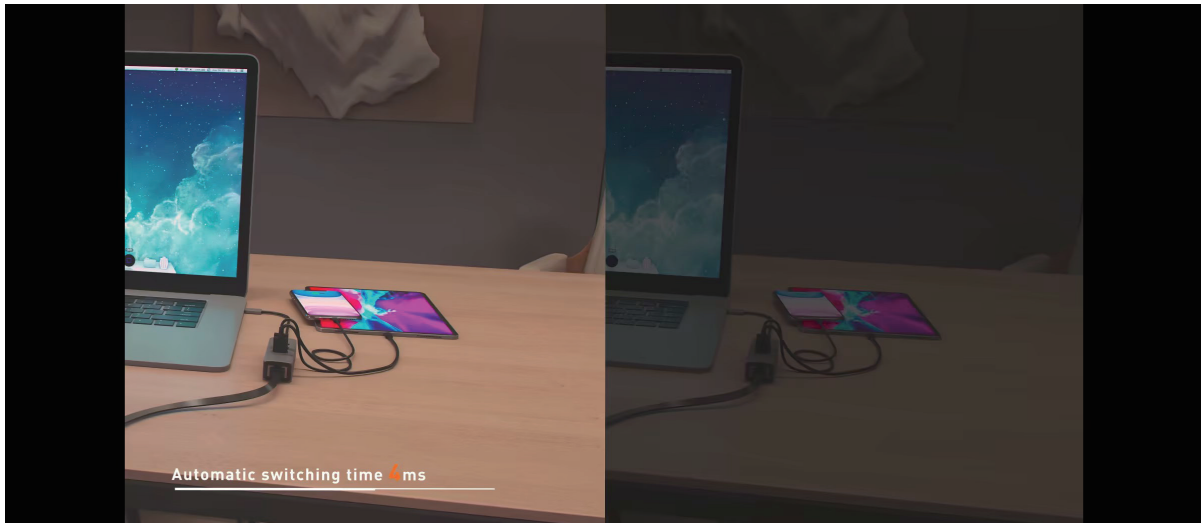

3. Stronger load capacity

Furthermore, many appliances with large instantaneous start-up power require more abundant power when starting in daily life. Without surge capabilities, this will affect the power supply voltage and cause some sensitive electrical appliances, such as TVs and computers, to malfunction. The backup output capacity of the Solis S6 Advanced Power Hybrid Inverter has been increased to twice the rated power and lasts for 10 seconds, which can meet the working requirements of all types of household loads.

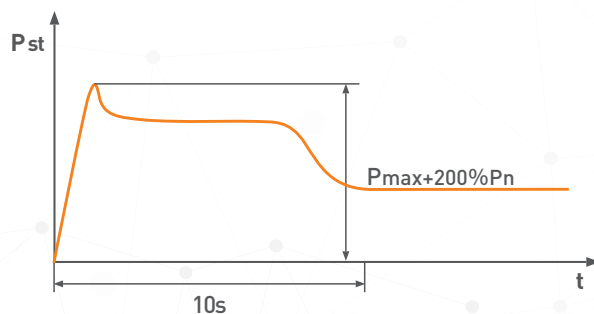

III. Excellent Electrical Performance - 24-Hour Enjoyment of Sunlight

1. Faster charging and discharging speed

Outages can last up to 6-8 hours and for those type of outages the battery bank needs to be large. In order for those batteries to be full, the inverter technology has to follow. The charging and discharging current of the product can reach 190 Amps, which enables you to quickly charge your batteries when the grid is active or the PV production is high. This will quickly prepare the user for the next outage and ensure the batteries can last throughout the whole period.

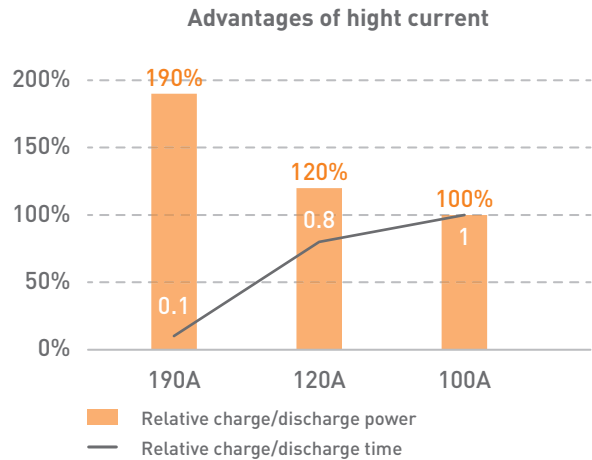

2. Sufficient DC/AC ratio

The maximum DC ratio of the Solis S6 Advanced Power Hybrid Inverter reaches 160%. By introducing the energy storage system, the photovoltaic energy exceeding the inverter's rated output power can be stored in the battery instead of being wasted, thereby maximizing the use of photovoltaic energy, making photovoltaic power meet all-weather demand, and improving the power generation and utilization per unit area.

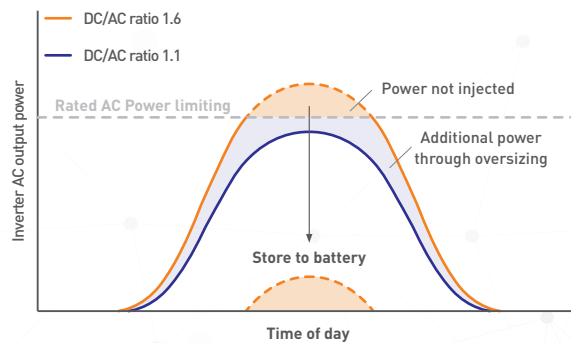
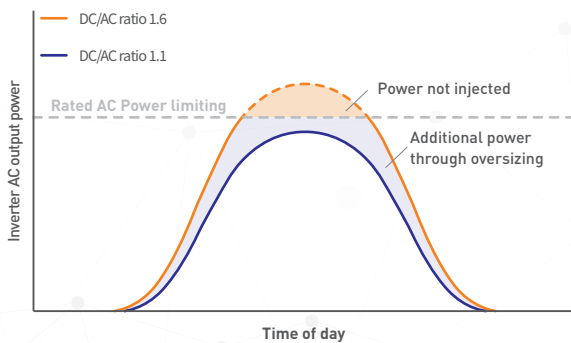

3. Larger DC input current

The input current of the Solis S6 Advanced Power Hybrid Inverter has been increased to 16A, making it more suitable for systems designed with high-efficiency, high-power photovoltaic modules, such as 550W or even 600W photovoltaic modules. Under a limited installation area, the capacity can be increased by 3% to 11%.

Impact of PV high current input on system capacity

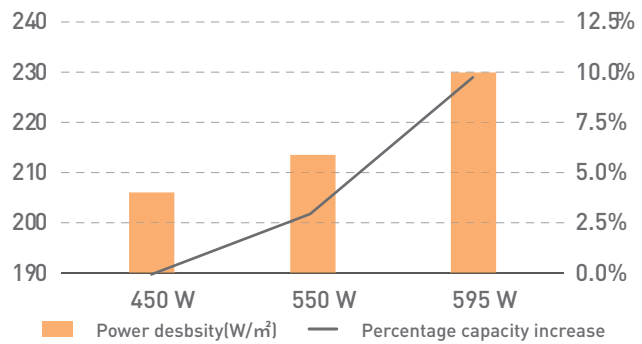

IV. Intelligent and Flexible Functional Design - Easier Application

1. 6-stage intelligent charging and discharging settings

The Solis S6 Advanced Power Hybrid Inverter provides 6-stage customizable charging and discharging time settings, optimizing household electricity usage habits through reasonable charging and discharging settings, thereby reducing electricity expenses.

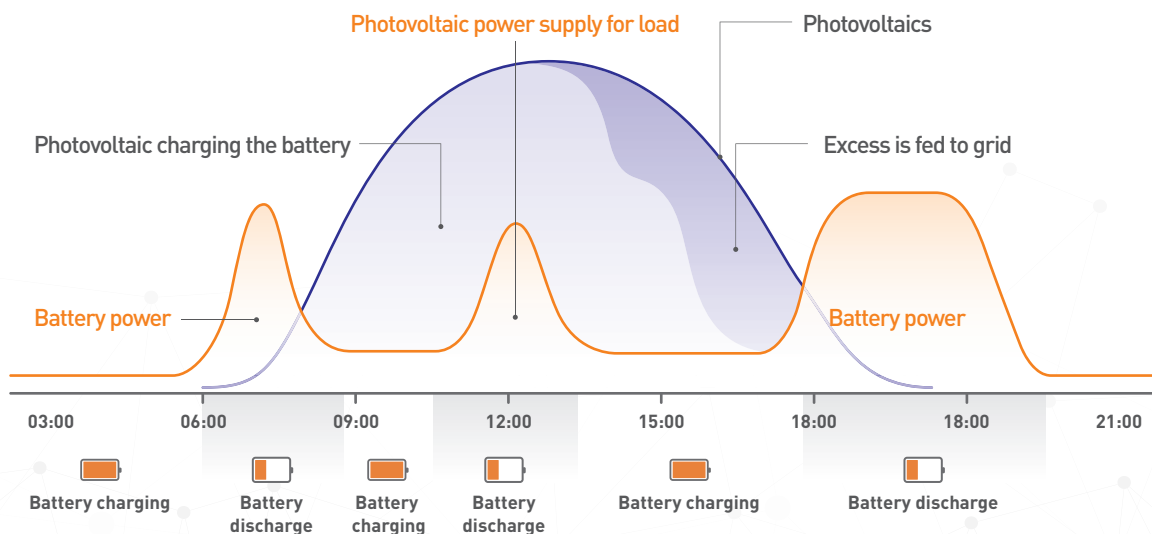

2. Single-phase/three-phase flexible grid connection

The Solis S6 Advanced Power Hybrid Inverter supports up to 6 devices in parallel for system expansion, forming a maximum 48kW hybrid power network while supplying power to three-phase and single-phase loads. When you need to build small and medium-sized commercial energy storage systems, this product enables it with its flexibility.

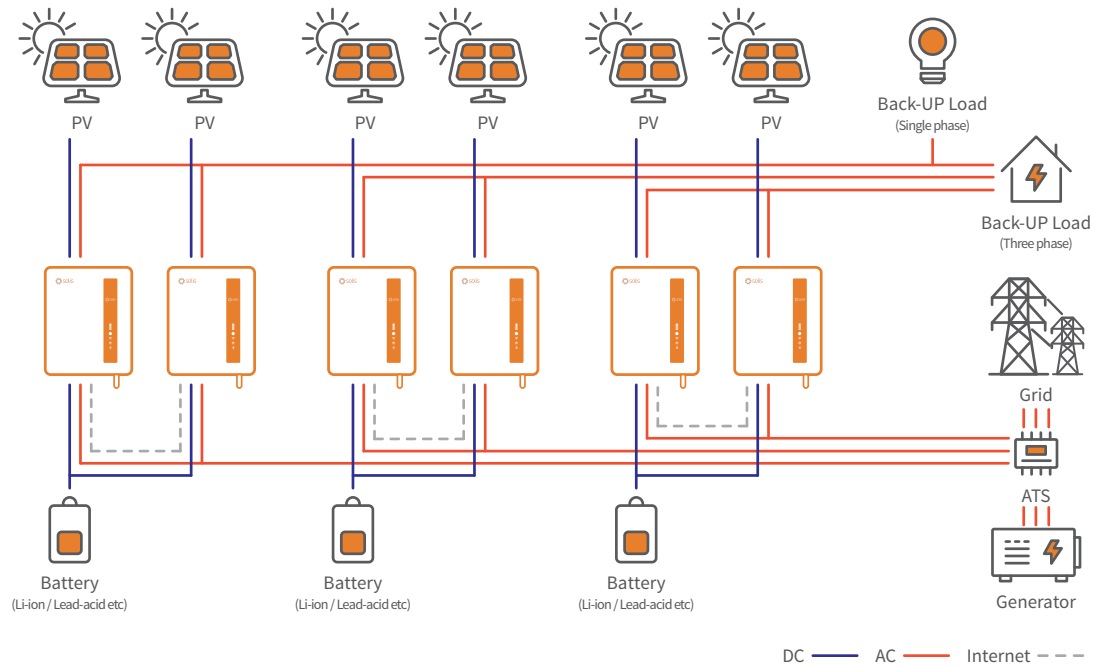

3. AC coupling extension

In this mode, the S6 hybrid inverter can simulate the operation logic of the power grid, realize the network operation of the grid-tied PV inverter, and realize the start and stop of the grid-tied PV inverter through SOC setting and frequency control.

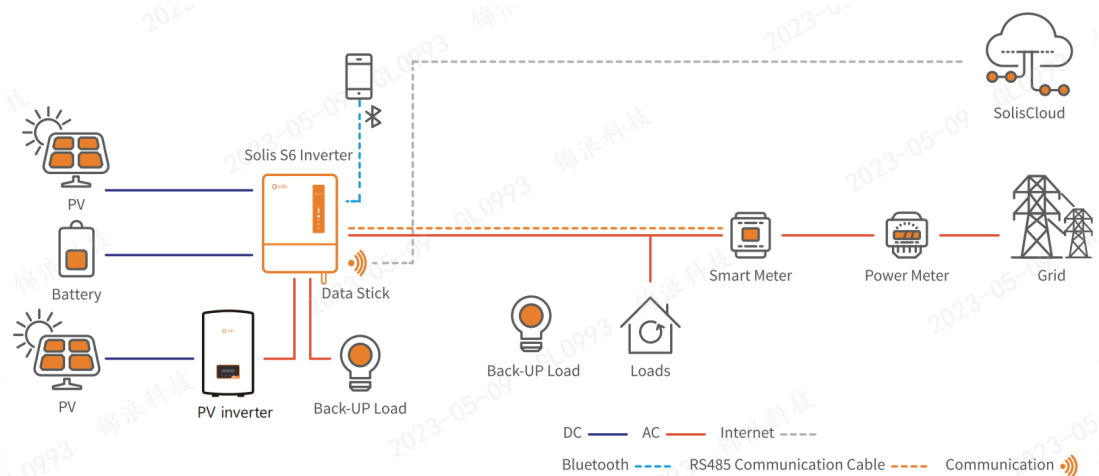

— AC coupling on Gen port

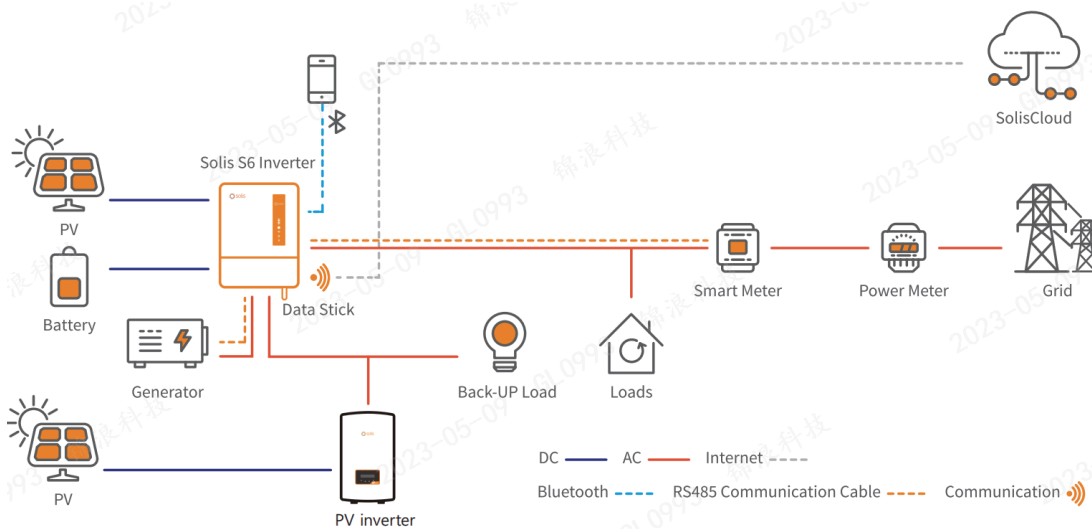

— AC coupling on Backup port

4. More flexible battery matching strategy

Solis cooperates with many excellent battery brands. These batteries work perfectly with the Solis S6 Advanced Power Hybrid Inverter, allowing customers to choose their preferred battery (lead-acid or lithium batteries) and complete the configuration with a simple battery selection option.



Compared to integrated energy storage systems, this strategy has the following advantages:

1. Customers can flexibly customize the system scale and expand systems according to their needs.
2. They have greater control over system cost efficiency by being able to choose between brands.
3. Customers can choose between a local brand or a long-time favorite or when their favorite brand has availability issues: they have the power to choose a 2nd or 3rd option!

V. Rich Working Modes - Adapting to Various Scenarios

Solis S6 Advanced Power Hybrid Inverter supports multiple working modes, meeting the power supply requirements of different application scenarios. These modes include self-use, feed-in priority, off-grid, backup and peak shaving. The specific illustrations are as follows:

(For the working principle and logic expression please refer to the energy flow image below)

Working mode	Working logic	Application scenario
Self-use (Self-use)	<ol style="list-style-type: none"> 1. Photovoltaic power generation is prioritized for the load, with excess power charging the battery. When the battery is full, excess power is fed into the grid; the battery discharges to the load at night. 2. Supports 6-stage charging and discharging settings. 3. The battery retention mode is included, battery SOC can be set, and the over-discharge range is 0% to 100% 	<p>Self-use scenario</p> <p>Self-use frequency is higher than 90%</p>
Feed in priority (Feed in priority)	<ol style="list-style-type: none"> 1. Photovoltaic power generation is prioritized for the load, excess power is supplied to the grid, and the battery maintains its basic charge. 2. Supports 6-stage charging and discharging settings; 3. The battery retention mode is included, battery SOC can be set, and the over-discharge range is 0% to 100% 	<p>Grid-connected areas with subsidies</p>
Off-grid mode (Off-grid)	<p>Passive start: When the grid is lost, the inverter passively enters off-grid mode, and the backup port outputs in pure off-grid mode.</p>	<p>Areas without grid access</p>
Peak shaving mode (peak shaving)	<p>User load power consumption from the grid is set lower than the peak power limit; remaining power can be supplemented by photovoltaic, battery pack, or diesel generator.</p>	<p>Areas with "capacity billing" requirements and power consumption greater than the combined photovoltaic + energy storage power</p>

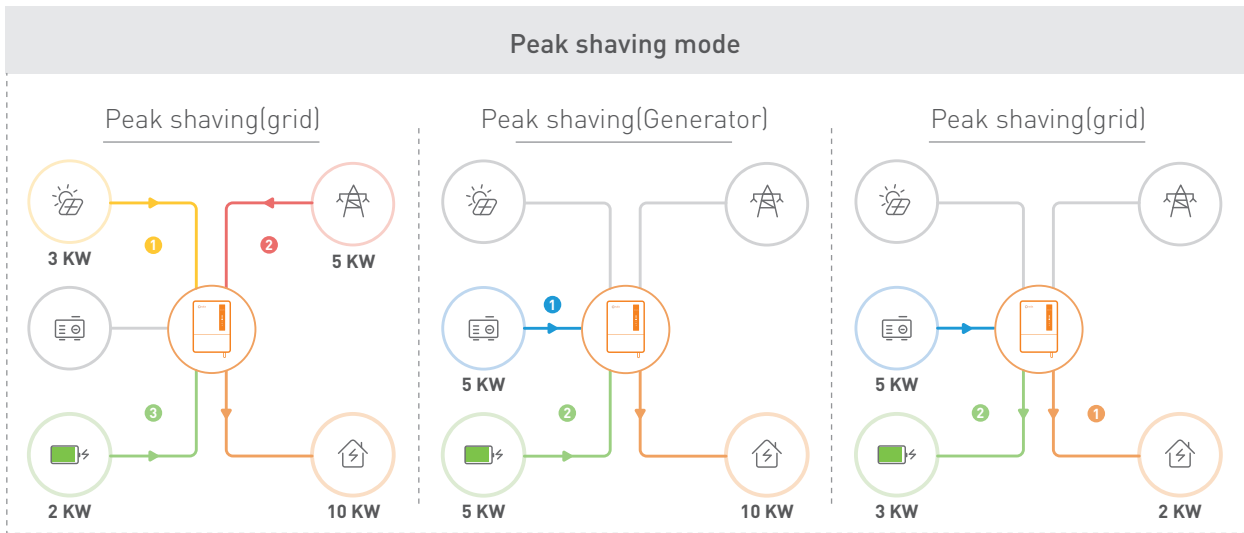
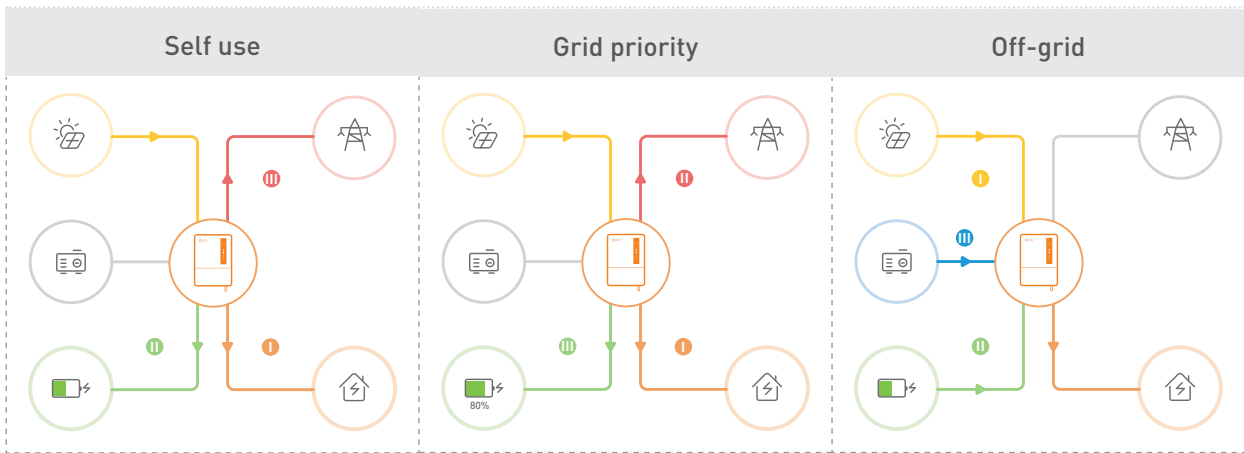

Conclusion:

>> The S6 Advanced Power Hybrid Inverter is the pinnacle of all the technologies we have achieved. It represents a powerful tool for a difficult time in locations around the world that desperately want to keep their power on. We hope that this product's rich function and outstanding performance will bring you the ultimate power experience and let the world's night sky no longer be dark.

